

GEEMARC

CLEAR SOUND[®]

HEAR THE DIFFERENCE

AmpliPOWER 40/50

English



!!!Warning, AmpliPOWER40/50 has an extra loud receiving volume gain!!! (Risk of acoustic shock)

!!!Attention, l'AmpliPOWER40/50 possède un amplificateur de volume très puissant!!! (Risque de choc acoustique)

!!!Seien Sie vorsichtig: der AmpliPOWER40/50 hat ein sehr starke Lautstärke!!! (Akustisches Schockrisiko)

geemarc
Telecom SA

!!!User manual to read carefully before start to use!!!

!!!Manuel d'utilisation à lire impérativement avant la mise en service!!!

!!! Bevor Ihr neues Telefongerät zu benutzen, bitte lesen Sie dies Benutzerhandbuch sehr sorgfältig!!!

CAUTION: this telephone is specifically designed for the people with hearing difficulties and is provided with a handset earpiece volume control for individual requirements. Due care must be taken by all users that the handset earpiece volume control is set to the lowest level acceptable by each respective user. Care should therefore be exercised to ensure that any naive users are familiar with this requirement.

ATTENTION: Ce téléphone peut être destiné aux personnes ayant des problèmes auditifs. il possède un écouteur a volume variable. A la première utilisation, assurez vous que le volume soit réglé au minimum. Les personnes malentendantes pourront par la suite augmenter le volume pour l'adapter à leur besoin.

WARNUNG: Dieses Telefon wurde speziell für schwerhörige Personen konzipiert und besitzt eine auf die individuellen Bedürfnisse einstellbare Hörerlautstärke. In Folge dessen sollten alle Nutzer darauf achten, dass der Lautstärkeregler des Hörers, in Rücksicht auf andere Nutzer, auf das niedrigste Niveau gestellt wird. Es ist darauf zu achten, dass unwissende Benutzer mit der Handhabung dieser Apparatur vertraut gemacht werden.

INDEX

Description	5-7
Setting up	
1 - Connecting the telephone	8
2 - Alarm and ring options	8
-Ring only	
-Ring and shaker	
-Ring and strobe flash	
3 - Ringer settings	9
4 - Tone/Pulse switch (T/P)	10
5 - Time break recall switch (270/100)	10
6 - Hotel message waiting switch	10
7 - Wall mounting	11
Using the phone	
8- Answering incoming calls	12
-Without headset	
-With headset (option)	
-In handsfree mode	
9- Volume and tone receiving	13

10 - Making a call	15
- Without headset	
- With headset (option)	
- In handsfree mode	
11 - Last number redial	16
12 - Recall, * & # buttons	16
13 - Mute button	17
14 - Storing telephone numbers	17
15 - Dialling stored numbers	18

Options:

16 - Direct Vibe handset	19
17 - Shaker	20
18 - Headset with microphone	20

Guarantee	21
------------------	-----------



**For product support and help visit our
website at www.geemarc.com
telephone 01707 384438
or fax 01707 372529**

Description

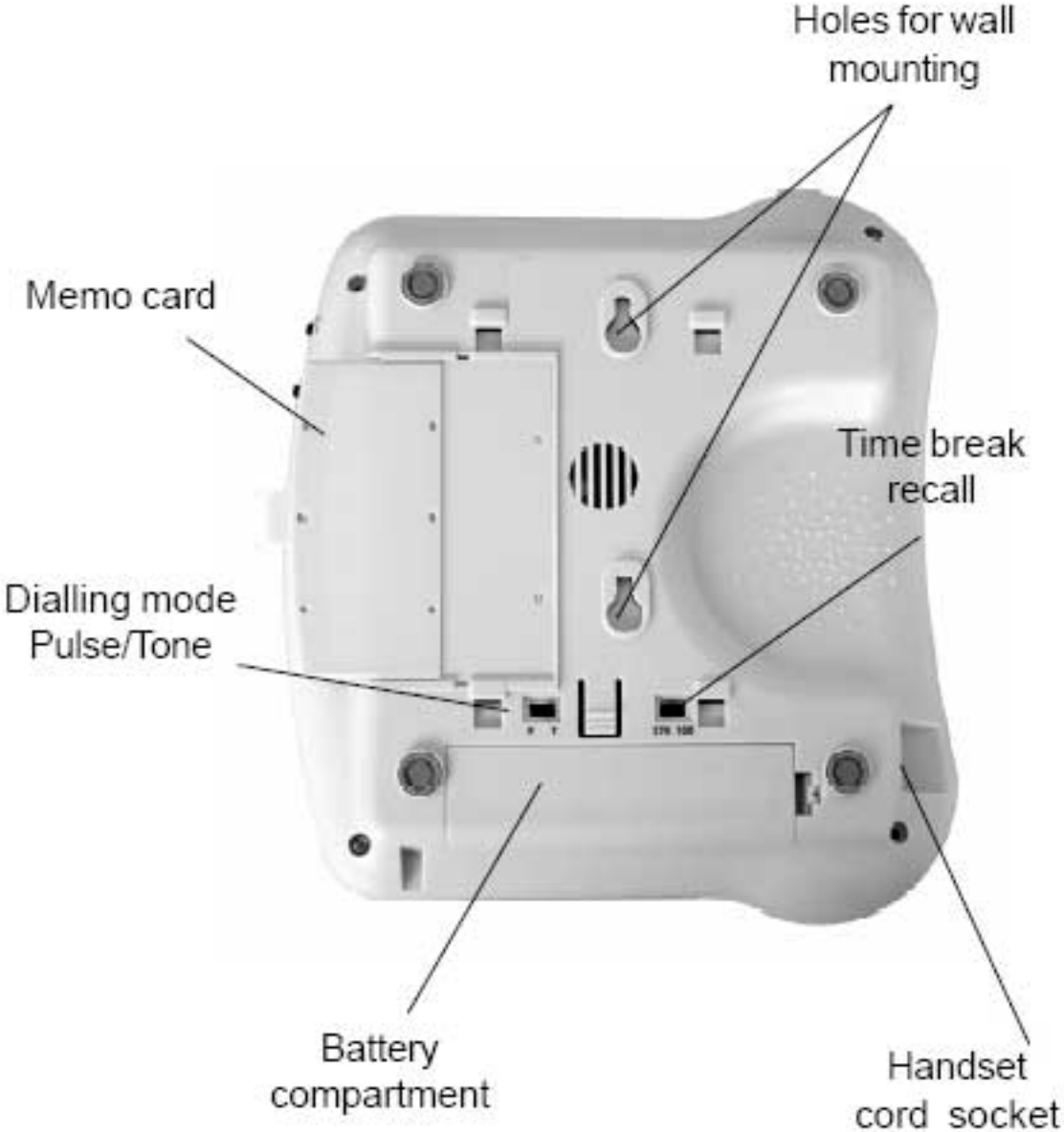



Ring alarm
setting

Ring Hi/Low/
OFF Switch

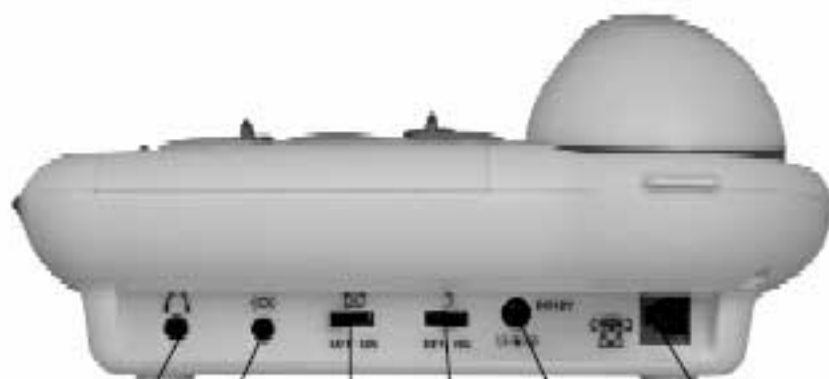

Headset socket

Shaker socket

Hotel switch
message

Volume and tone
adjustment ON/OFF switch

Adaptator
socket

Line socket

Setting up

1- Connecting the telephone

- Connect the handset cord.
- Open the battery door by unscrewing the retaining screw. Insert 4 x AAA alkaline batteries (not included).

Snap the battery door in place.



In case of power failure, batteries are required for the ring.

- Connect the line cord.
- Connect the shaker cord (optional).
- Connect the headset cord (optional).
- Connect the PTT plug to the wall socket.
- Connect the 12V DC adaptor cord to the telephone.
- Connect the 12V DC adaptor to your wall socket (**).

(**) Classified "hazardous voltage" according to EN60950 standard.

2- Alarm and ringer volume setting

A 3 position switch located on the right side of the phone allows the settings below:

-  : Ringer and shaker are activated.
-  : Ringer and strobe flash are activated.

3- Ringer settings

A switch located on right side allows the ringer to be switched HI,LOW,OFF:

 : Off,  : Low,  : Hi

Your phone comes with the ringer switched to «High» and the melody set to «6».

	Low	Mid	High
Melody 1	1	2	3
Melody 2	4	5	6 (by default)
Melody 3	7	8	9

If you don't like the ringer melody, you can choose a new one by changing the settings as follow:

- Lift the handset.
- Press  button.
- Press # button.
- Press any button 1 to 9.

Ringer will be activated on next call.

- 0 : Only the ringer is activated.

4- Tone/Pulse switch (T/P)

The Tone/Pulse switch is factory pre-set to Tone position (**T**). In the UK, all telephone exchanges now use Tone dialling. If your phone does not dial out, it is probably being used from an older private switch-board (PBX). In this case, the Tone/Pulse switch must be moved to Pulse.

5- Time break recall switch (270/100)

For the UK, the TBR switch is factory pre-set to 100ms. It can be switched to 270ms for other locations or PBX's.

6- Hotel message waiting switch

These are used with the new services provided on hotel network. A switch  located behind your phone allows to set **ON** the hotel message waiting function. When the switch is setting **ON** and when you receive a message, the red light is

lit to inform you that you have a message on the phone.

7- Wall mounting

Drill 2 holes in the wall (80 mm apart).

Insert the wall plugs and the screws leaving about 6 mm of the screws projecting from the wall. Slide the telephone downwards to secure

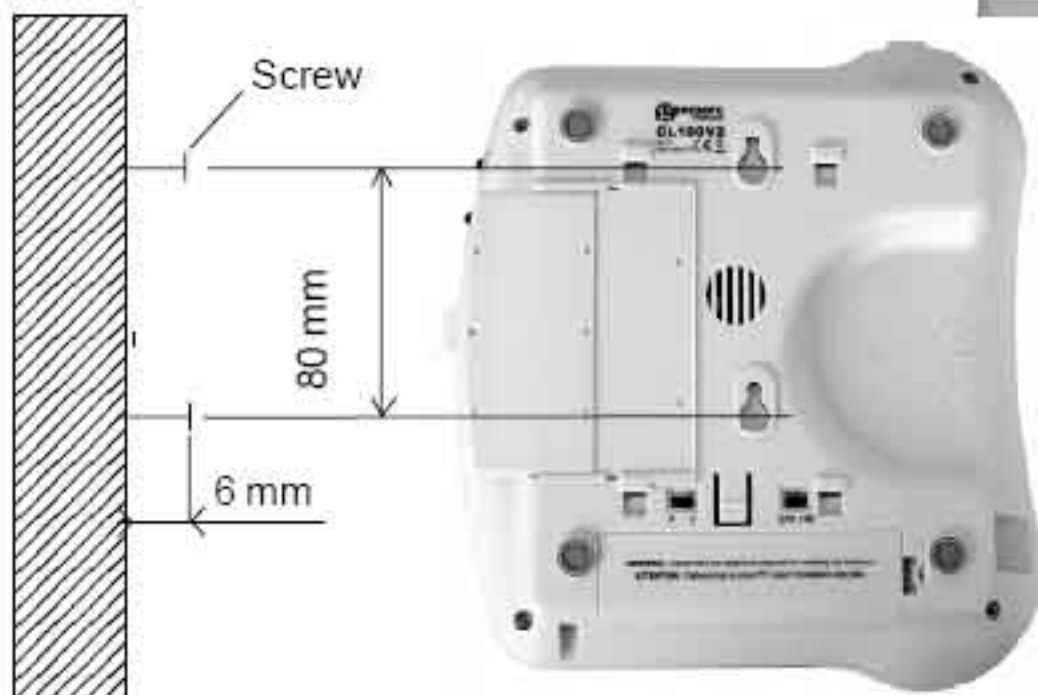

Using the phone

8- Answering incoming call

Without headset:

- When an incoming call is received the phone will ring, to answer the call lift the handset and speak.
- On completion of the call, carefully replace the handset in the cradle to release the line.

With headset (option):

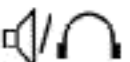
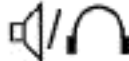
- When an incoming call is received, and if you wish to answer the call with the headset, press the  button and speak.
- On completion of the call, press the  button again to release the line.

In handsfree mode:

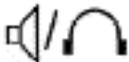
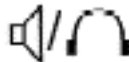
- When an incoming call is received, the phone will ring, to answer the call press the  button.
- On completion of the call, press the  button to release the line.

9 - Volume and tone receiving adjustment

You can increase the volume and adjust the receiving tone according to your own hearing requirements. The button +40 dB allows extra-receiving and tone functions to be activated or not during the conversation.

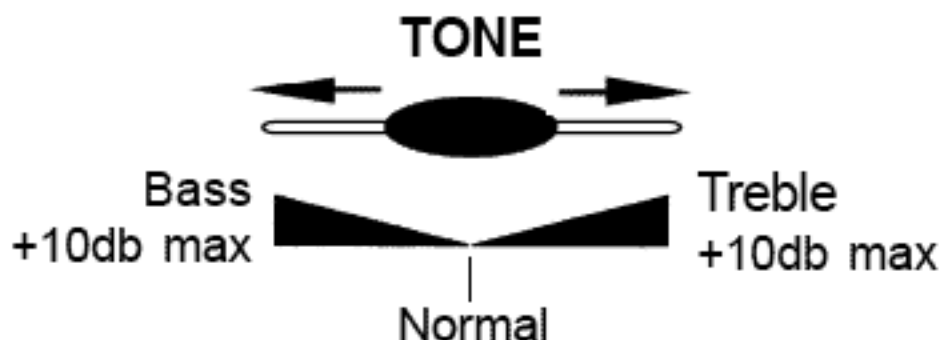

When the function is activated, the red light for extra-receiving and tone function located near the button +40 dB is lit. Adjust the **TONE** and **VOLUME** buttons to move the level according to your own hearing requirements.

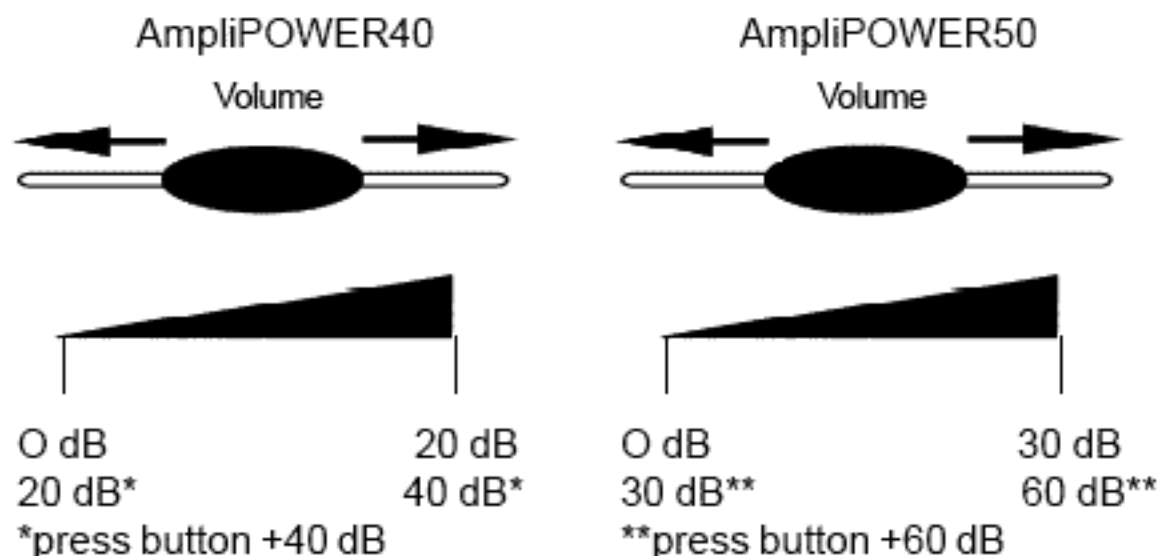

Using the phone



Note:



When the switch  located behind the phone is **ON**, the extra-receiving and tone functions are automatically activated each time you use the phone. When the switch  is switched **OFF**, you will need to activate the function by pressing the button + 40dB (or +60 dB for the AmpliPOWER 50). Tone and volume adjustment (20dB to 40dB for the AmpliPOWER 40 and 30 dB to 60 dB for the AmpliPOWER 50) is only activated when the button is set to **ON**. When this button is set to **OFF** only the volume can be adjusted from 0 dB to 20 dB (0 dB to 30 dB for the AmpliPOWER 50)

10- Making a call



Without headset:

- Lift the handset.
- Await the dial tone and dial required number.
- On completion of the call, carefully replace the handset in the cradle.

With headset (option):

- Press the  button.
- Await the dial tone and dial required number.
- On completion of the call, press the  button again to clear the line.

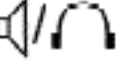
In handsfree mode

- Press the  button.
- Await the dial tone and dial required number.
- On completion of the call, press the  button to release the line.
- If your correspondent doesn't answer your call, press the  button again to release the line.

Note:

- To deactivate the handsfree function during a call, lift the handset.

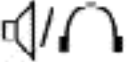
To activate the handsfree function during a call, press the  button and place the handset on the cradle.

- During a call in handsfree, you can adjust the speaker volume to a desirable level.

Simply use the slide control VOLUME located on the left of the unit.

11- Last number redial

- Lift the handset.



- Await the dial tone and press  button.

- The previously dialled number will be automatically redialled (not in use for memory numbers).

12- Recall, * & # Buttons

These are used with the new services provided on digital exchanges. For details please contact your network operator.

13- Mute button

If you wish to speak privately to someone else in the room without your caller overhearing, press and hold the  button. You will still be able to hear the callers but they cannot hear you during the mute operation. To resume normal conversation, release the  button.



14- Storing telephone number

Your phone can store 12 direct memories including 3 priority numbers (21 digits maximum for each memory).

For example, the 3 priority **P1**, **P2**, **P3** memories allow you to store the 3 numbers below:

- Local, Police station,
- Your doctor
- 1471

To store a number please follow instructions below:

- Lift the handset.
- Press  button.
- Press **M1**, **M2**, ..., or **M9** or one of 3 priorities numbers to store your number.
- Dial the number.
- Press  button again.

Numbers will be lost after a few hours if you disconnect your phone. Entering a new number in memory will automatically erase the previous number.

15- Dialling stored number

- Lift the handset and await the dial tone.
- Press appropriate button **M1**, **M2**, ..., or **M9** or one of the 3 priorities **P1**, **P2**, **P3** numbers, the stored number will be dialled automatically.

To register your stored phone numbers, use the index card located under the base.

16- Direct vibe handset (optional)

If you have conductive hearing loss you can use a Direct Vibe Handset, try placing the Direct Vibe handset on your telephone, in front and slightly below your ear or behind your ear to see which position works best for you.

If you don't have hearing loss you can use your phone normally and put the receiver on your ear.

If you require a Direct Vibe Handset ref: CLA4 you may purchase it from your retailer or audiologist.

In case of difficulty please visit our website (www.geemarc.com) or phone our HELPLINE 01707 384 438 .

To set up the Direct Vibe handset, disconnect the standard handset from the curly cord, then replace it with the Direct Vibe handset.

17- Shaker (Optional)

If you wish to compliment you phone by using a SHAKER ref: CLA2 connect the shaker plug in the socket  located over the back edge of the telephone. When an incoming call is received, the shaker will be activated when the phone rings.

Note: This option must be set in the ALARM AND RINGER OPTIONS item (page 9) to be activated. To purchase a SHAKER see item 1 above.

18- Headset with microphone (optional)

If you wish to answer or make calls by using a Geemarc headset ref: CLA3, connect the headset plug in the headset socket  located over the back edge of the telephone.

Note:When using a headset, the speaker will be activated and it's recommended to adjust the speaker to the low position.

Recycling directives :

The WEEE (Waste Electrical and Electronic Equipment) has been put in place for the products at the end of their useful life are recycled in the best way.



When this product is finished with, please do not put it in your domestic waste bin.

Please use one of the following disposal options:

- Remove the batteries and deposit them in an appropriate WEEE skip. Deposit the product in an appropriate WEEE skip.
- Or, hand the old product to the retailer. If you purchase a new one, they should accept it.

Thus if you respect these instructions you ensure human health and environmental protection.

Guarantee :

From the moment your Geemarc product is purchased, Geemarc guarantee it for the period of one year. During this time, all repairs or replacements (at our option) are free of charge. Should you experience a problem then contact our helpline or visit our website at www.geemarc.com. The guarantee does not cover accidents, negligence or breakages to any parts. The product must not be tampered with or taken apart by anyone who is not an authorised Geemarc representative. The Geemarc guarantee in no way limits your legal rights.

Important : YOUR RECEIPT IS PART OF YOUR GUARANTEE AND MUST BE RETAINED AND PRODUCED IN THE EVENT OF A WARRANTY CLAIM.

Telephone connection : Voltages present on the telecommunication network are classified TNV-3 (Telecommunication Network Voltage) according to the EN60950 standard.

Declaration : Hereby Geemarc Telecom SA declares that this product is in compliance with the essential requirements and other relevant of the Radio and Telecommunications Terminal Equipment 1999/5/EEC and in particular article 3 section 1a, 1b and section 3.



 **Geemarc UK**

5 Swallow Court
Swallowfields
Welwyn Garden City
Hertfordshire, AL7 1SB
For product support:
01707 384438

www.geemarc.com

 **Geemarc France**

Parc de l'Etoile
2, rue Galilée
59760 Grande Synthe
Tél. service après vente:
03 28 58 75 99

www.geemarc.com

 **Geemarc Germany**

Walter Kolb Str. 9-11
60594 Frankfurt
F: 069 9621 7635

www.geemarc.com